

13" X 22" X 13" NEMA 4 ENCLOSURE

SKU: AL132213N4



- Constructed For Indoor & Outdoor Application
- Durable 1/8" 5052 Aluminum Construction
- Weathertight 1/4" Rubber Door Seals
- Adjustable / Removable Equipment Mounting Plate
- Security Lock with Key
- Includes a Pair of Wall / Pole Enclosure Mount Plates

OVERVIEW

13" x 22" x 13" NEMA 4 weatherproof enclosure is manufactured from 5052 Aluminum. This construction resists rusting and corrosion making it ideal for use for marine applications as well as other rugged environments. Each enclosure includes a sunshade, insulation, triangular cam lock, and universal mounting brackets. These brackets allow for installers to mount the enclosure directly to a wall (flush mount), or mount to a pole using banding brackets (optional accessory). A removable back-plate allows for items to be installed vertically and assembled outside of the enclosure. Temperature control available with a heater.

Applications: Commonly found in data centers, guarding gates, housing controls, along river & ocean fronts, on docks, in boat storage facilities or marinas, commercial areas, & more.

SPECIFICATIONS

Material	1/8" 5052 Aluminum
NEMA Rating	4
Mounting Brackets	2x Universal Wall / Pole Brackets - Bands not included
Door Seals	1/4" Weather Tight Neoprene
Equipment Mounting Plate	1x (19" x 11")
Security Lock	Yes (2x keys included)
Dimensions: External	22.1875" W x 13.875" H x 14.125" D
Dimensions: Internal Max	21.8125" W x 12.75" H x 13.5" D
Dimensions: Internal Min	21.8125" W x 12.75" H x 11.75" D
Weight	35 lbs.



PRODUCT SPEC SHEET: AL132213N4

13" x 22" x 13" NEMA 4 ENCLOSURE

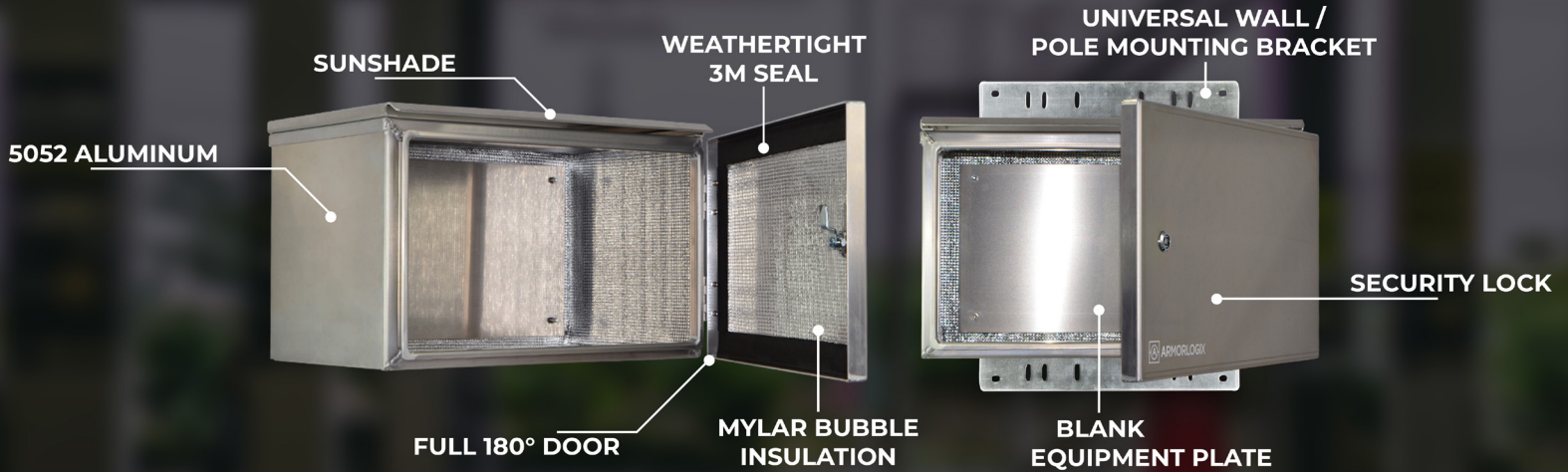

LEFT: AL132213N4
RIGHT: AL132213N4

PRODUCT FEATURES

360° Cooling

Each Armorlogix enclosure comes standard with both a built-in sunshade and 2x Universal Mounting Brackets enabling true 360° cooling around the outside of your enclosure. The included sunshade allows for additional natural temperature control and airflow, and the rain guard prevents water from collecting on the top of the door seals. The sunshield also acts like a heat sink by absorbing heat from within the enclosure and then dispersing it by colder air circulating past the top. In addition, the ArmorLogix sunshield reflects the sun's rays from hitting the top of the enclosure helping reduce additional sources of heat the interior of the enclosure. By keeping the enclosure away from the wall, the Universal Mounting Plate's offset design allows for a full 360° of airflow circulation, and keeps interior condensation at a minimum.

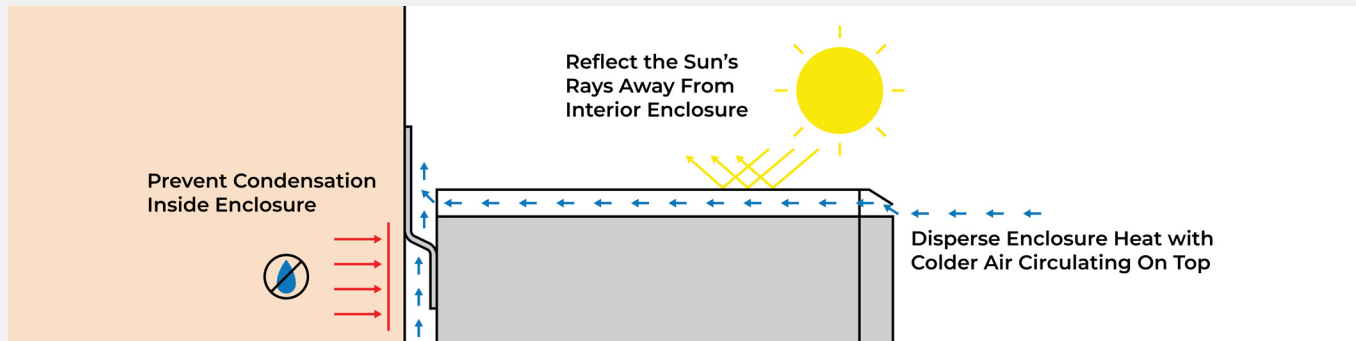
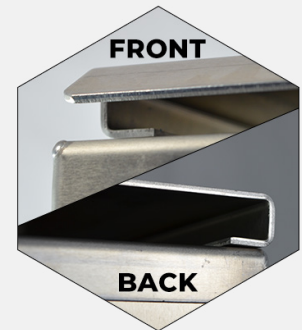

PRODUCT SPEC SHEET: AL132213N4

13" x 22" x 13" NEMA 4 Enclosure



Marine Grade Aluminum

All ArmorLogix weatherproof enclosures are constructed using Marine Grade 5052 Aluminum which provides better rust and corrosive protection than standard stainless steel. The aluminum material also allows for quicker heat dissipation and is lighter in weight than many other weather-proof enclosures of similarly sized steel enclosures.

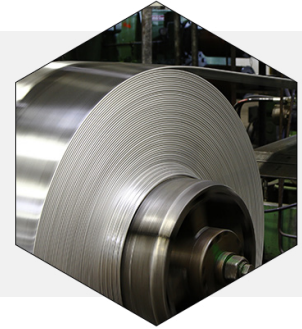

Universal Mounting Brackets

All enclosures come standard with (2) 16" universal mounting brackets made from 3/16" Aluminum. The offset design allows for a full 360° of airflow circulation, and keeps interior condensation at a minimum. Mount your enclosure easily to a wall, pole or other mounting options like Unistrut. With multiple pole banding slots users can mount ArmorLogix enclosures anywhere.

*Ensure your mounting option can support the weight of the enclosure and installed equipment.

Blank Equipment Plate

Included in each enclosure is a blank aluminum equipment mounting plate, that is both adjustable and removable. By being removable, ArmorLogix's blank aluminum equipment plate allows the user to mount their own equipment easily both inside the enclosure or outside and removes the need to drill additional holes into the enclosure.



Secure Lock

All enclosures from ArmorLogix come with a secure camlock, and a set of (2) keys. These can be upgraded to padlockable handles, or other keyed locks upon request. View all enclosure locking options.

Mylar Bubble Insulation

Mylar bubble insulation is two layers of 1/8" barrier bubble film laminated between two layers of metalized film. Our enclosures when paired with Mylar Bubble Insulation helps keep the interior of your box climate controlled.

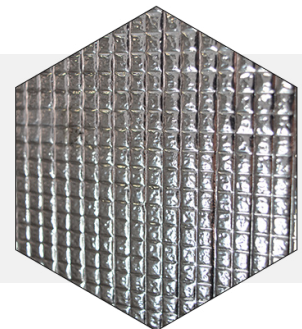

PRODUCT SPEC SHEET: AL132213N4

13" x 22" x 13" NEMA 4 ENCLOSURE

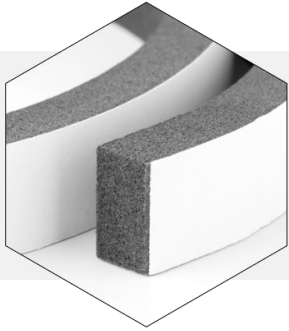

Weathertight 3M Seal

ArmorLogix enclosures come standard with a weathertight 3M seal preventing the environment from getting inside the enclosure. This 1/4" thick Neoprene seal is a high-quality material and is rugged to extended abuse and remains flexible in a wide range of temperatures and conditions.

NEMA 4 – Non-Vented Enclosures

This ArmorLogix enclosure is rated NEMA 4 providing protection against splashing, dripping water, precipitation, and airborne dust and dirt particles. Learn about the differences between NEMA ratings.



RELATED PRODUCTS



27" x 22" x 13"
NEMA 4 ENCLOSURE

AL272213N4



20" x 22" x 22"
NEMA 4 ENCLOSURE

AL202222N4



19" x 19" x 12"
NEMA 3 ENCLOSURE

AL191912N3



12" x 12" x 11"
NEMA 4 ENCLOSURE

AL121211N4

ADDITIONAL ACCESSORIES



PADLOCKABLE HANDLE

ALHANDLE-P



CELLULAR MODEM

AL4G



120V THERMOSTATIC
ENCLOSURE HEATER

ALHTR150-P



45° POLE MOUNTING
BRACKET

ALPOLEBKT-45-2

PRODUCT SPEC SHEET: AL132213N4

13" x 22" x 13" NEMA 4 ENCLOSURE



DIMENSIONS

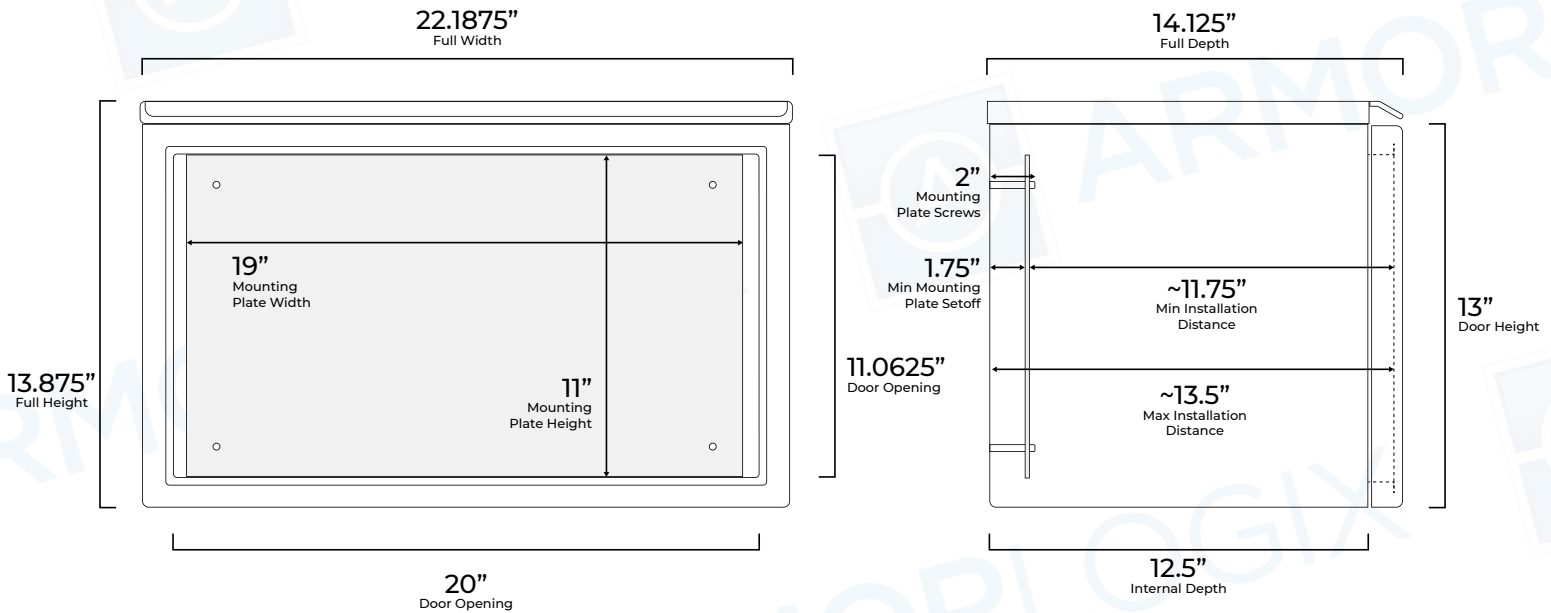

ADDITIONAL IMAGES

