

Waterproof Standalone Access Controller

Quick Start Guide





V1.0.1

General

This document elaborates device structure, installation and system function of waterproof standalone access controller.

Safety Instructions

The following categorized signal words with defined meaning might appear in the Manual.

Signal Words	Meaning
 DANGER	Indicates a high potential hazard which, if not avoided, will result in death or serious injury.
 WARNING	Indicates a medium or low potential hazard which, if not avoided, could result in slight or moderate injury.
 CAUTION	Indicates a potential risk which, if not avoided, could result in property damage, data loss, lower performance, or unpredictable result.
 TIPS	Provides methods to help you solve a problem or save you time.
 NOTE	Provides additional information as the emphasis and supplement to the text.

Privacy Protection Notice

As the device user or data controller, you might collect personal data of others' such as face, fingerprints, car plate number, Email address, phone number, GPS and so on. You need to be in compliance with the local privacy protection laws and regulations to protect the legitimate rights and interests of other people by implementing measures include but not limited to: providing clear and visible identification to inform data subject the existence of surveillance area and providing related contact.

About the Manual

- The Manual is for reference only. If there is inconsistency between the Manual and the actual product, the actual product shall prevail.
- We are not liable for any loss caused by the operations that do not comply with the Manual.
- The Manual would be updated according to the latest laws and regulations of related regions. For detailed information, see the paper User's Manual, CD-ROM, QR code or our official website. If there is inconsistency between paper User's Manual and the electronic version, the electronic version shall prevail.
- All the designs and software are subject to change without prior written notice. The product

updates might cause some differences between the actual product and the Manual. Please contact the customer service for the latest program and supplementary documentation.

- There still might be deviation in technical data, functions and operations description, or errors in print. If there is any doubt or dispute, please refer to our final explanation.
- Upgrade the reader software or try other mainstream reader software if the Guide (in PDF format) cannot be opened.
- All trademarks, registered trademarks and the company names in the Manual are the properties of their respective owners.
- Please visit our website, contact the supplier or customer service if there is any problem occurred when using the device.
- If there is any uncertainty or controversy, please refer to our final explanation.

Important Safeguards and Warnings

The following description is the correct application method of the device. Please read the manual carefully before use, in order to prevent danger and property loss. Strictly conform to the manual during application and keep it properly after reading.

Operating Requirement

- Please don't place and install the device in an area exposed to direct sunlight or near heat generating device.
- Please don't install the device in a humid, dusty or fuliginous area.
- Please keep its horizontal installation, or install it at stable places, and prevent it from falling.
- Please don't drip or splash liquids onto the device; don't put on the device anything filled with liquids, in order to prevent liquids from flowing into the device.
- Please install the device at well-ventilated places; don't block its ventilation opening.
- Use the device only within rated input and output range.
- Please don't dismantle the device arbitrarily.
- Please transport, use and store the device within allowed humidity and temperature range.

Power Requirement

- Please make sure to use batteries according to requirements; otherwise, it may result in fire, explosion or burning risks of batteries!
- To replace batteries, only the same type of batteries can be used!
- The product shall use electric wires (power wires) recommended by this area, which shall be used within its rated specification!
- Please make sure to use standard power adapter matched with this device. Otherwise, the user shall undertake resulting personnel injuries or device damages.
- Please use power supply that meets SELV (safety extra low voltage) requirements, and supply power with rated voltage that conforms to Limited Power Source in IEC60950-1. For specific power supply requirements, please refer to device labels.
- Products with category I structure shall be connected to grid power output socket, which is equipped with protective grounding.
- Appliance coupler is a disconnecting device. During normal use, please keep an angle that facilitates operation.

Table of Contents

Foreword	II
Important Safeguards and Warnings	IV
1 Overview	1
2 Installation Guide	2
2.1 Device Dimension	2
2.2 Device Structure.....	3
2.3 Device Installation.....	4
3 System Structure	5
3.1 System Structure Diagram.....	5
3.2 Wiring	5
4 Functional Setting	7
4.1 Enter Main Menu.....	7
4.2 Modify Admin Password.....	7
4.3 Add User	8
4.4 Delete User	8
4.5 Set Unlocking Mode.....	9
4.6 Set Opening Time	9
4.7 Set Device Working Mode	10
4.8 Set Door Sensor.....	10
4.9 Restore Defaults	10
5 Optiview VMS Config	11
5.1 Log in Client	11
5.2 Add Access Controller.....	11
5.2.1 Auto Search	11
5.2.2 Manual Add.....	13
6 Technical Parameters	16

Waterproof standalone access controller integrates card reading, config and execution functions. With a neat appearance and IPX6 waterproof grade, it can be used outdoors.

Its abundant function is as follows:

- Touch keyboard, TCP/IP protocol, support 30,000 valid cards and 60,000 records.
- Support to unlock via card, card + password and user ID + password.
- Support door overtime alarm, intrusion alarm, duress alarm, and tamper alarm.
- Add guest card, duress card, black/white list and patrol card, while support period of validity or times.
- Support 128 groups of schedule, 128 groups of period and 128 groups of holiday period.

2.1 Device Dimension

Device dimension is shown in Figure 2-1.

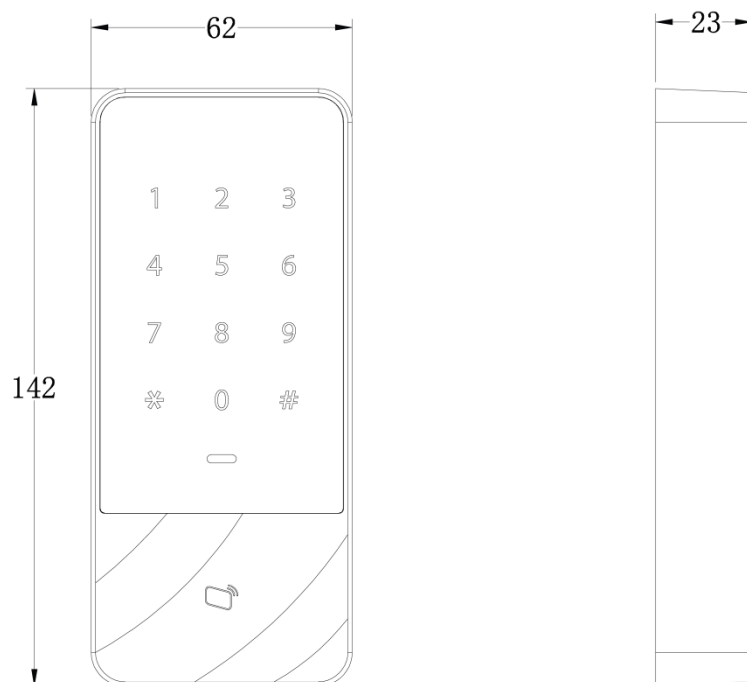

Figure 2-1

2.2 Device Structure

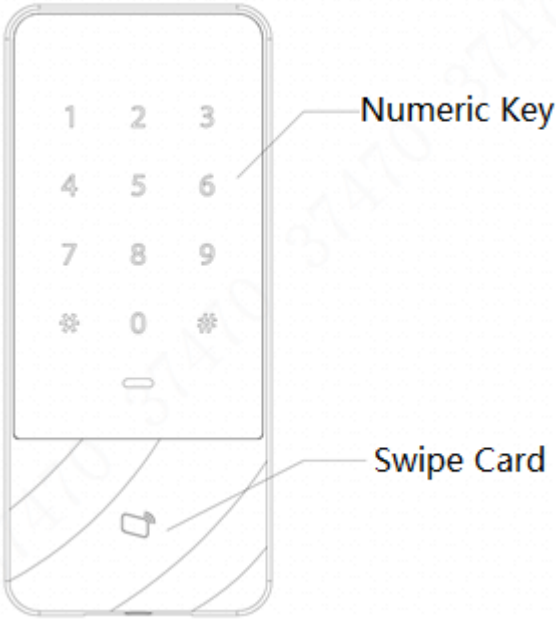

Figure 2-2

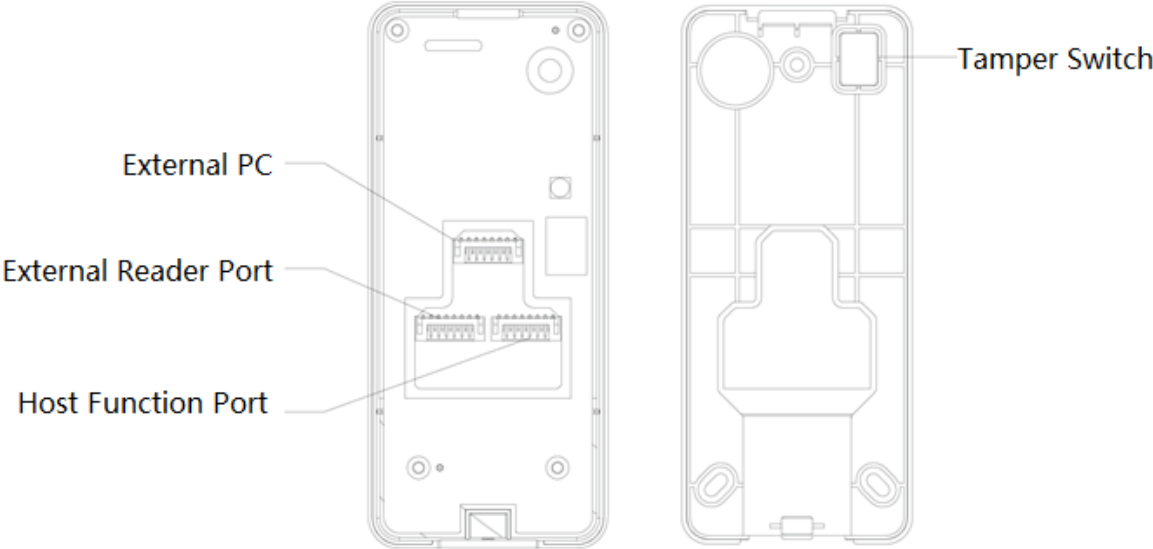

Figure 2-3

2.3 Device Installation

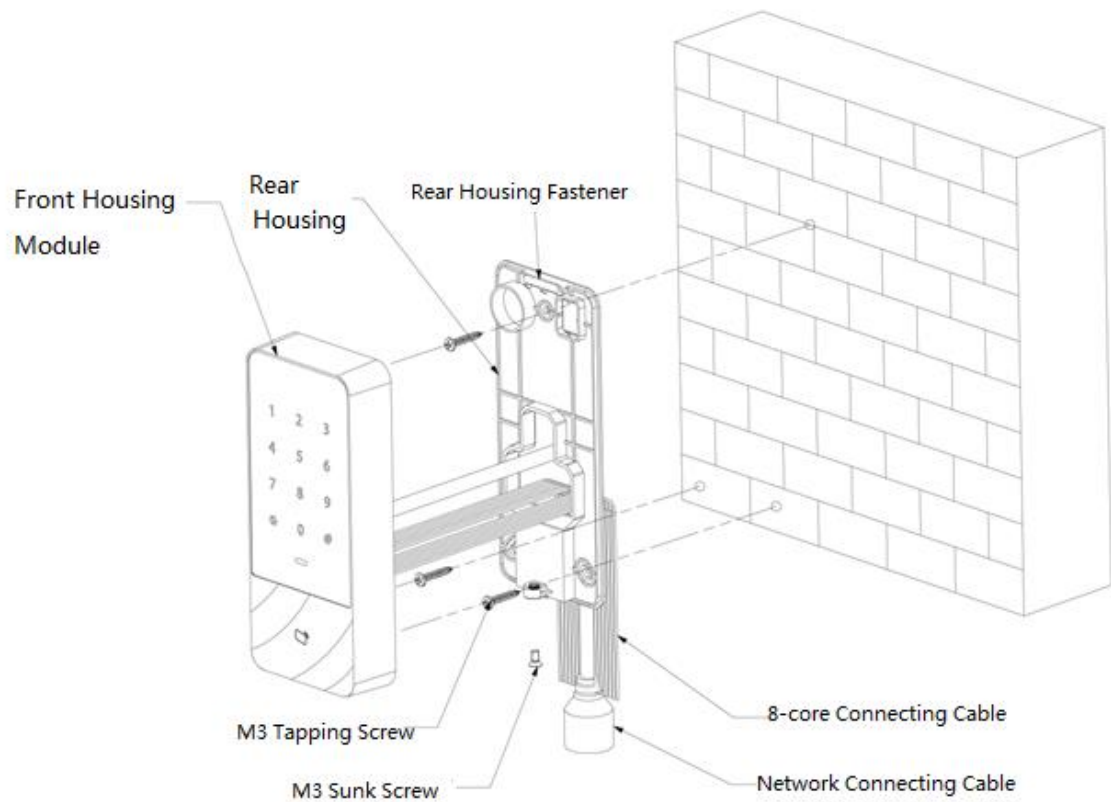

Figure 2-4

- Step 1 Fix the rear housing onto the wall with M3 tapping screw; reserve a wiring space for networking connecting cable between the rear housing and wall.
- Step 2 Pass the network connecting cable and two 8-core connecting cable from the space between rear housing and wall, neaten them in wiring duct, and then tighten M3 tapping screw.
- Step 3 Push the top of front housing module into rear housing fastener, close the lower part, and tighten M3 sunk screw at the bottom.

3 System Structure

3.1 System Structure Diagram

The device, card reader, alarm device, access control PC and etc. compose a system as in Figure 3-1.

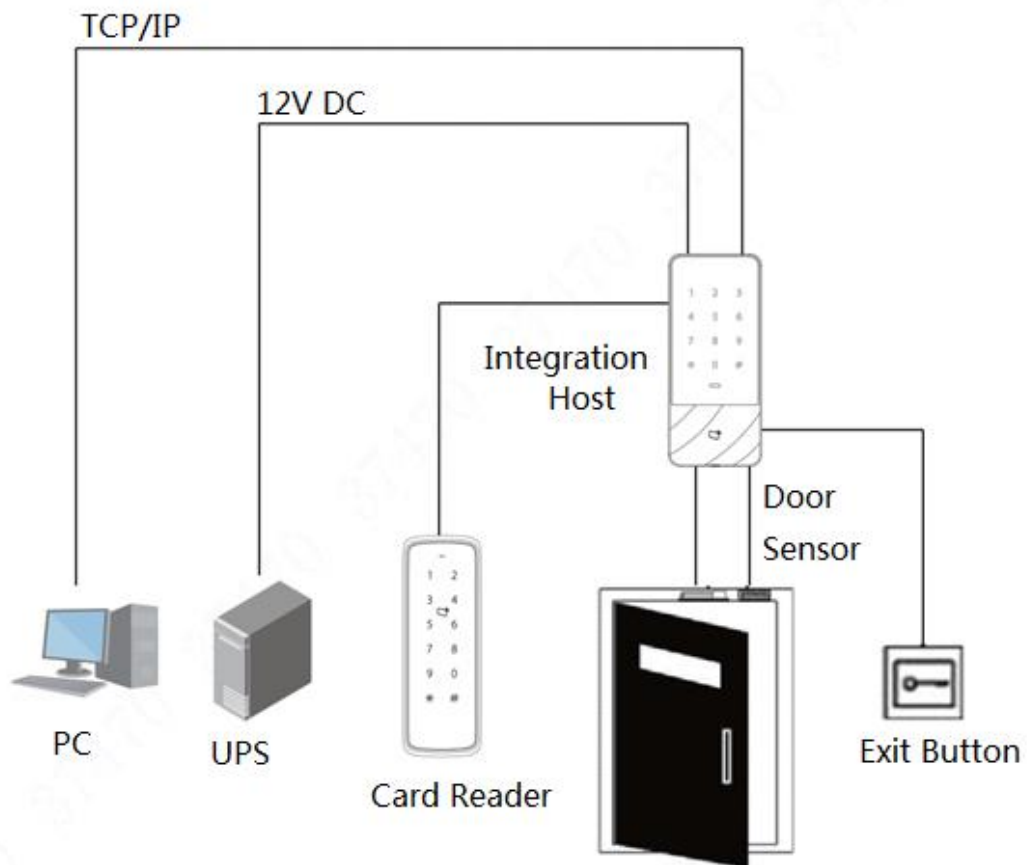

Figure 3-1

3.2 Wiring

Wiring terminals of the device is shown in Figure 3-2. Please refer to Table 3-1 for details.

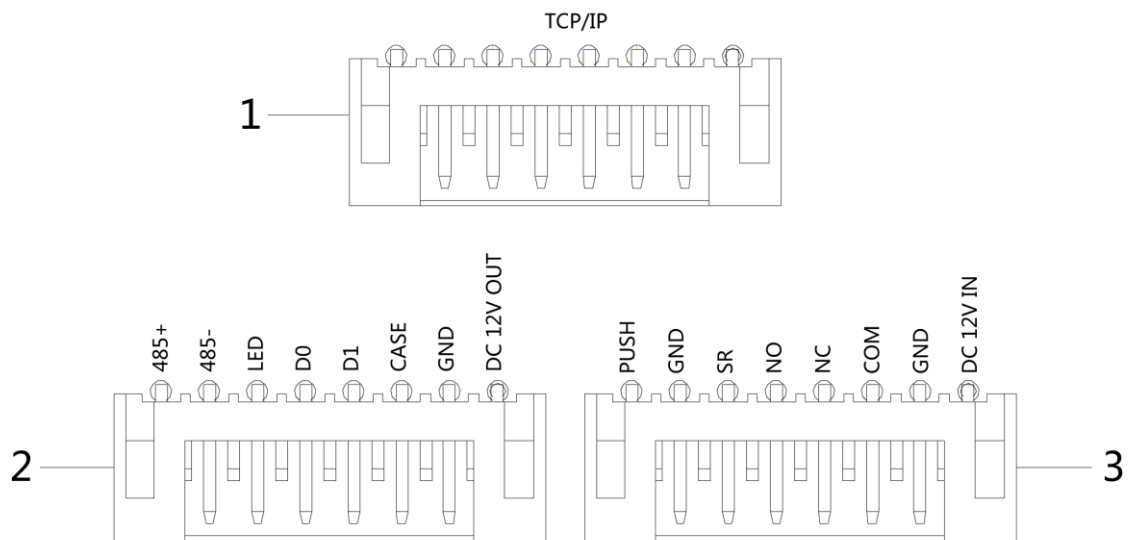

Figure 3-2

No.	Terminal	Description
1	RJ45	TCP/IP, network interface.
2	485+	RS485+, 485 reader.
	485-	RS485-, 485 reader.
	LED	Wiegand card swiping indicator signal line
	D0	D0, Wiegand reader.
	D1	D1, Wiegand reader.
	CASE	Tamper input of reader.
	GND	Connect GND.
	DC 12V OUT	DC 12V power supply of reader.
3	PUSH	Connect the exit button.
	GND	Connect GND, which is shared by door sensor and exit button.
	SR	Door sensor detection.
	NO	NO end of door lock.
	NC	NC end of door lock.
	COM	Lock relay.
	GND	Connect GND.
	DC 12V IN	DC 12V power input.

Table 3-1

4 Functional Setting

4.1 Enter Main Menu

Touch the panel to wake it up; enter the main menu to set corresponding functions.

Step 1 Touch the panel to wake it up, and press [#] key.

 Note

Indicator light is blue and normally on and numeric keyboard turns on, representing that the panel has been woken up.

Step 2 Input admin password and press [#] key.

 Note

- Default admin password is 123456, Default IP 192.168.0.2 (no web service).
- Indicator light is blue and flashing, which means that you've entered main menu successfully.
- Indicator light is red and normally on; after the buzzer beeps for three times, the indicator light is blue and normally on. It means that wrong password was input, so it failed to enter the main menu.

After entering the main menu, press numeric keys to set corresponding functions. Please refer to Table 4-1 for the relation between numeric keys and functions.

 Note

- After setting the functions, press [*] key to return to previous menu.
- At the main menu, press [*] key to exit the main menu.

Numeric Key	Function
0	Modify admin password.
1	Add user.
2	Delete user.
3	Unlock verification mode.
4	Set the hold time of door lock relay.
5	Device working mode.
6	Enable door sensor.
9	Restore defaults.

Table 4-1

4.2 Modify Admin Password

 Note

For security, please modify admin password timely.

Step 1 Wake up the panel to enter the main menu.

Step 2 Press **[0]** + **[#]** key.

Step 3 Input new password and press **[#]** key.

Step 4 Input the new password again (both new password shall be the same), and press **[#]** key.

Password is modified successfully. Please login with the new password next time.

 Note

- Indicator light is green and normally on, and the buzzer beeps once, which means that password has been modified successfully.
- Indicator light is red and normally on, and the buzzer beeps for three times, which means that it failed to modify the password.

4.3 Add User

Add a user and associate the user with card.

Step 1 Wake up the panel to enter the main menu.

Step 2 Press **[1]** + **[#]** key to add a user.

1. Add user ID. Input ID and end up with **[#]** key.

 Note

If the user ID exists already, it will fail to be added.

2. Add a card. Swipe a card and end up with **[#]** key.

 Note

If card number is not needed, press **[#]** key directly to skip this step.

3. Add password.

- ◇ If it is necessary to set password, input a password and press **[#]** key.
- ◇ Otherwise, press **[#]** key directly.

 Note

Please set the password if you don't swipe card to add card number. If password is not set, it will fail to be added.

One user is added after completing above 3 steps. Continue to add other users in this way.

After adding users, the system stays at "Add User" menu. Please press **[*]** key to return to the main menu.

 Note

- Indicator light is green and normally on, and the buzzer beeps once, which means that the user has been added successfully.
- Indicator light is red and normally on, and the buzzer beeps for three times, which means that it failed to add the user.

4.4 Delete User

Delete user info; the corresponding card info will be deleted and it won't have right to unlock the door.

Step 1 Wake up the panel to enter the main menu.

Step 2 Press **[2]** + **[#]** key.

- Swipe the card directly and press **[#]** key to delete the user.
- Input ID and press **[#]** key to delete the user.
- Input 0000 and press **[#]** key to delete all users.

After deleting users, the system stays at “Delete User” menu. Please press **[*]** key to return to the main menu.

 Note

- Indicator light is green and normally on, and the buzzer beeps once, which means that the user has been deleted successfully.
- Indicator light is red and normally on, and the buzzer beeps for three times, which means that it failed to delete the user.

4.5 Set Unlocking Mode

According to needs, set to unlock with card, card + password or user ID + password. Default mode is card or user ID + password.

Step 1 Wake up the panel to enter the main menu.

Step 2 Press **[3]** + **[#]** key.

Step 3 Select unlocking mode.

- Card or user ID+ password (default): unlock by swiping a card or with user ID+ password.

Press **[0]** + **[#]** key.

- Card + password: swipe the card and then input password.

Press **[1]** + **[#]** key.

- User ID + password: input user ID+ **[#]** key, and then input password + **[#]** key to unlock.

Press **[2]** + **[#]** key.

After setting is completed, the system returns to the main menu automatically. Press **[*]** to exit main menu.

4.6 Set Opening Time

With a relay, control door hold time. The door is kept open during the hold time, and is closed automatically after this period.

Step 1 Wake up the panel to enter the main menu.

Step 2 Press **[4]** + **[#]** key.

Step 3 Input the time (ranging from 1 to 600s) and press **[#]** key.

After setting is completed, the system returns to the main menu automatically. Press **[*]** to exit main menu.

4.7 Set Device Working Mode

The waterproof standalone access controller has two modes, namely controller and reader.

Step 1 Wake up the panel to enter the main menu.

Step 2 Press **[5]** + **[#]** key.

Step 3 Select working mode.

- Controller: open the door by swiping card. Default device is controller.

Press **[0]** + **[#]** key.

- Reader: it only reads card, rather than controlling the door.

Press **[1]** + **[#]** key.

After setting is completed, the system returns to the main menu automatically. Press **[*]** to exit main menu.

4.8 Set Door Sensor

Select whether door sensor is enabled or not. After enabling, the buzzer will give an alarm if the door is not closed when the time is out.

Step 1 Wake up the panel to enter the main menu.

Step 2 Press **[6]** + **[#]** key.

Step 3 Select whether door sensor is enabled.

- Disable: it is disabled by default.

Press **[0]** + **[#]** key.

- Enable:

Press **[1]** + **[#]** key.

After setting is completed, the system returns to the main menu automatically. Press **[*]** to exit main menu.

4.9 Restore Defaults

Restore all configurations to factory defaults.

Step 1 Wake up the panel to enter the main menu.

Step 2 Press **[9]** + **[#]** key.

Step 3 Input 000 and press **[#]** key.

After setting is completed, the system is rebooted automatically.

5

Optiview VMS Config

Access controller is managed with Optiview VMS client, so as to realize control and right configuration of one door and door groups.

This part mainly introduces quick configuration. For details, please refer to matching user's manual and Optiview VMS user's manual.

 Note

Optiview VMS client has different interfaces depending on the versions. Please refer to actual interface.

5.1 Log in Client

Install the matching Optiview VMS client, and double click to run. Carry out initialization configuration according to interface prompts and complete login.

5.2 Add Access Controller

Add access controller in Optiview VMS; select "Auto Search" and "Add".

5.2.1 Auto Search

Devices are required to be in the same network segment.

Step 1 In "Devices" interface, click "Auto Search", as shown in Figure 5-1.

The system displays "Auto Search" interface, as shown in Figure 5-2.

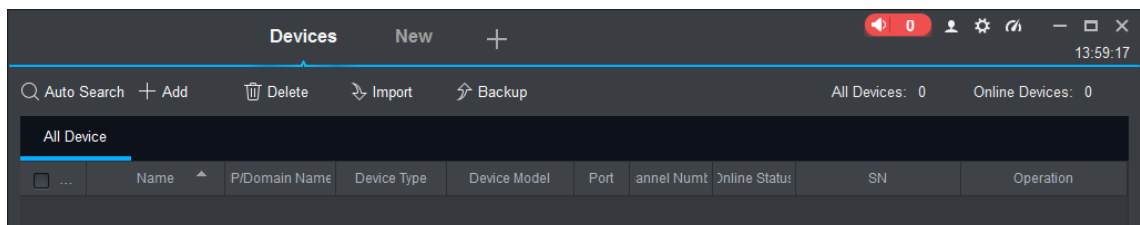

Figure 5-1

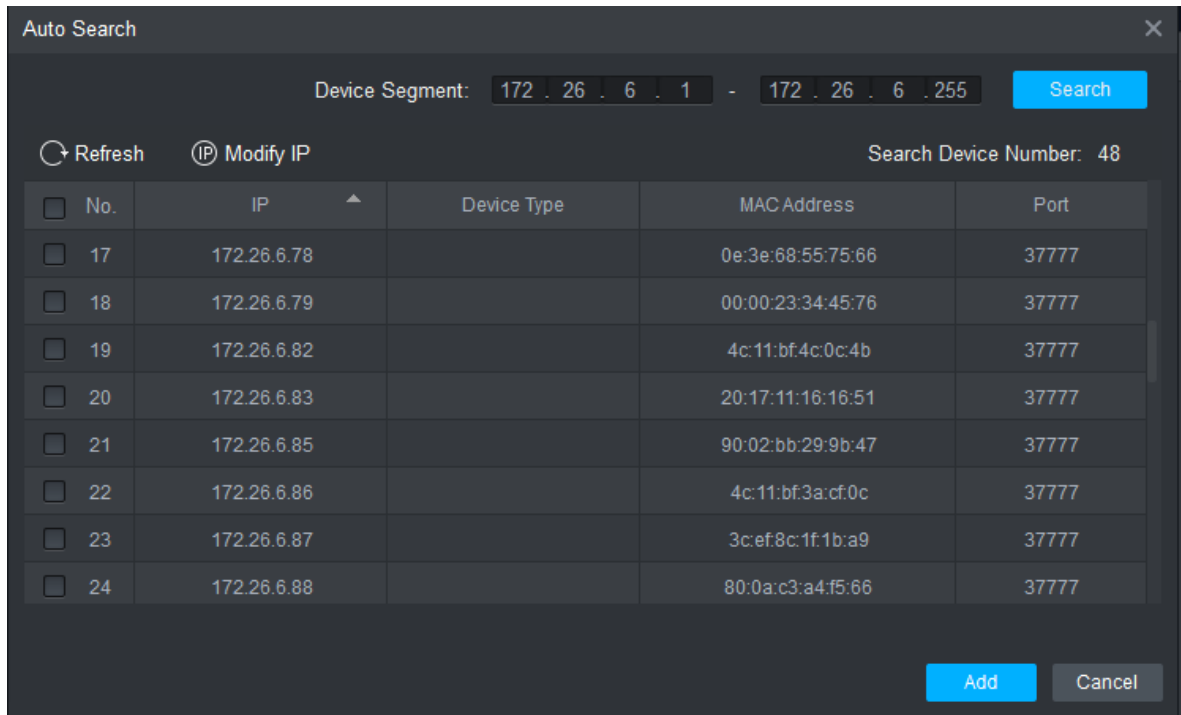

Figure 5-2

Step 2 Input device segment and click “Search”. The system displays search results.

Note

- Click “Refresh” to update device information.
- Select a device, click “Modify IP” to modify IP address of the device. For specific operations, please refer to User’s Manual of the VMS Client.

Step 3 Select the device that needs to be added, and click “Add”.

The system pops up “Prompt”.

Step 4 Click “OK”.

The system displays “Login Information” dialog box, as shown in Figure 5-3.

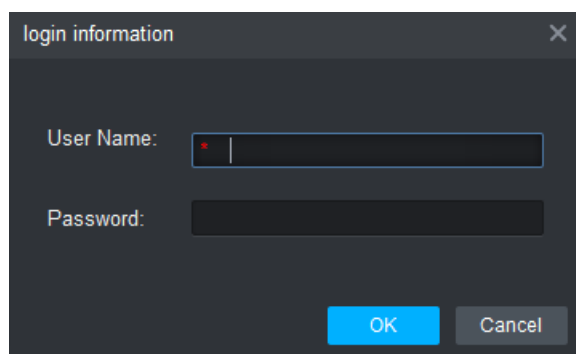

Figure 5-3

Step 5 Input “User Name” and “Password” to log in the device, and click “OK”.

The system displays the added device list, as shown in Figure 5-4.

Note

- After completing adding, the system continues to stay at “Auto Search” interface. You can continue to add more devices, or click “Cancel” to exit “Auto Search” interface.
- After completing adding, the VMS logs in the device automatically. In case of successful login, online status displays “Online”. Otherwise, it displays “Offline”.

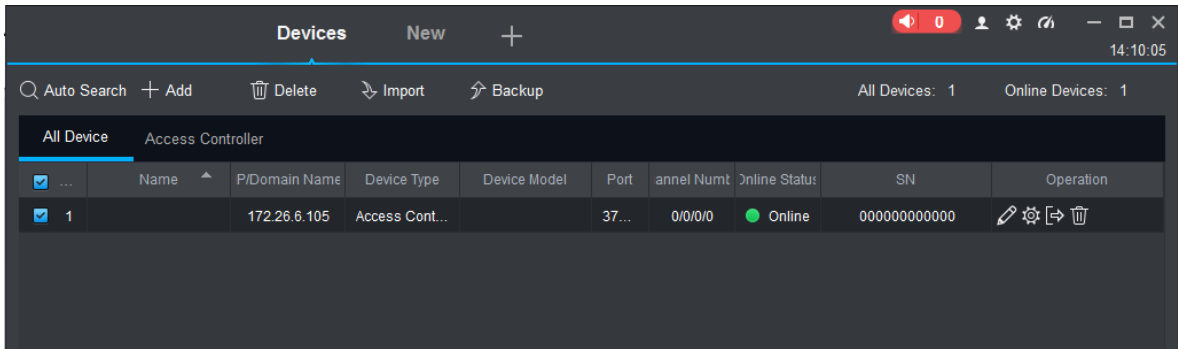

Figure 5-4

5.2.2 Manual Add

To add devices, device IP address or domain name shall be known first.

Step 1 In “Devices” interface, click “Add”, as shown in Figure 5-5.

The system pops up “Manual Add” interface, as shown in Figure 5-6.

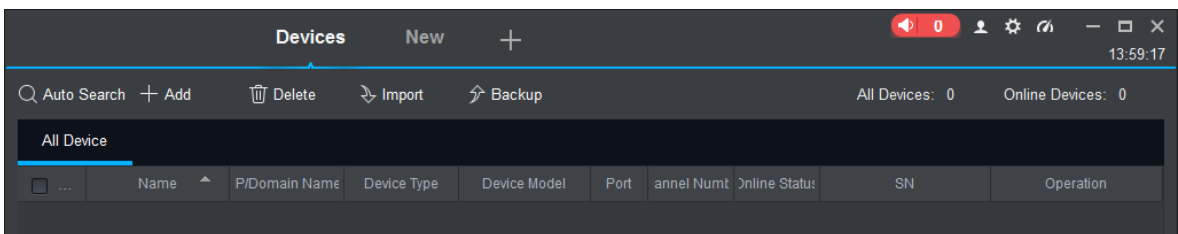

Figure 5-5

Manual Add ✕

Device Name: *

Method to add: IP/Domain ▼

IP/Domain Name: *

Port: * 37777

Group Name: Default Group ▼

User Name: *

Password:

Figure 5-6

Step 2 Set device parameters. For specific parameter descriptions, please refer to

Parameter	Description
Device Name	It is suggested that device name should be named by the monitoring zone, so as to facilitate maintenance.
Method to add	Select “IP/Domain Name”. Add devices according to device IP address or domain name.

IP/Domain Name	IP address or domain name of the device.
Port	Port number of the device. Default port number is 37777. Please fill in according to actual conditions.
Group Name	Select the group of the device.
User Name and Password	User name and password of the device.

Table 5-1.

Parameter	Description
Device Name	It is suggested that device name should be named by the monitoring zone, so as to facilitate maintenance.
Method to add	Select "IP/Domain Name". Add devices according to device IP address or domain name.
IP/Domain Name	IP address or domain name of the device.
Port	Port number of the device. Default port number is 37777. Please fill in according to actual conditions.
Group Name	Select the group of the device.
User Name and Password	User name and password of the device.

Table 5-1

Step 3 Click "Add" to add a device.

The system displays the added device list, as shown in Figure 5-4. Doors of the added controller are displayed under "Access" tab, as shown in Figure 5-7.

 Note

- To add more devices, click "Save and Continue", add devices and stay at "Manual Add" interface.
- To cancel the adding, click "Cancel" and exit "Manual Add" interface.
- After completing adding, the VMS logs in the device automatically. In case of successful login, online status displays "Online". Otherwise, it displays "Offline".

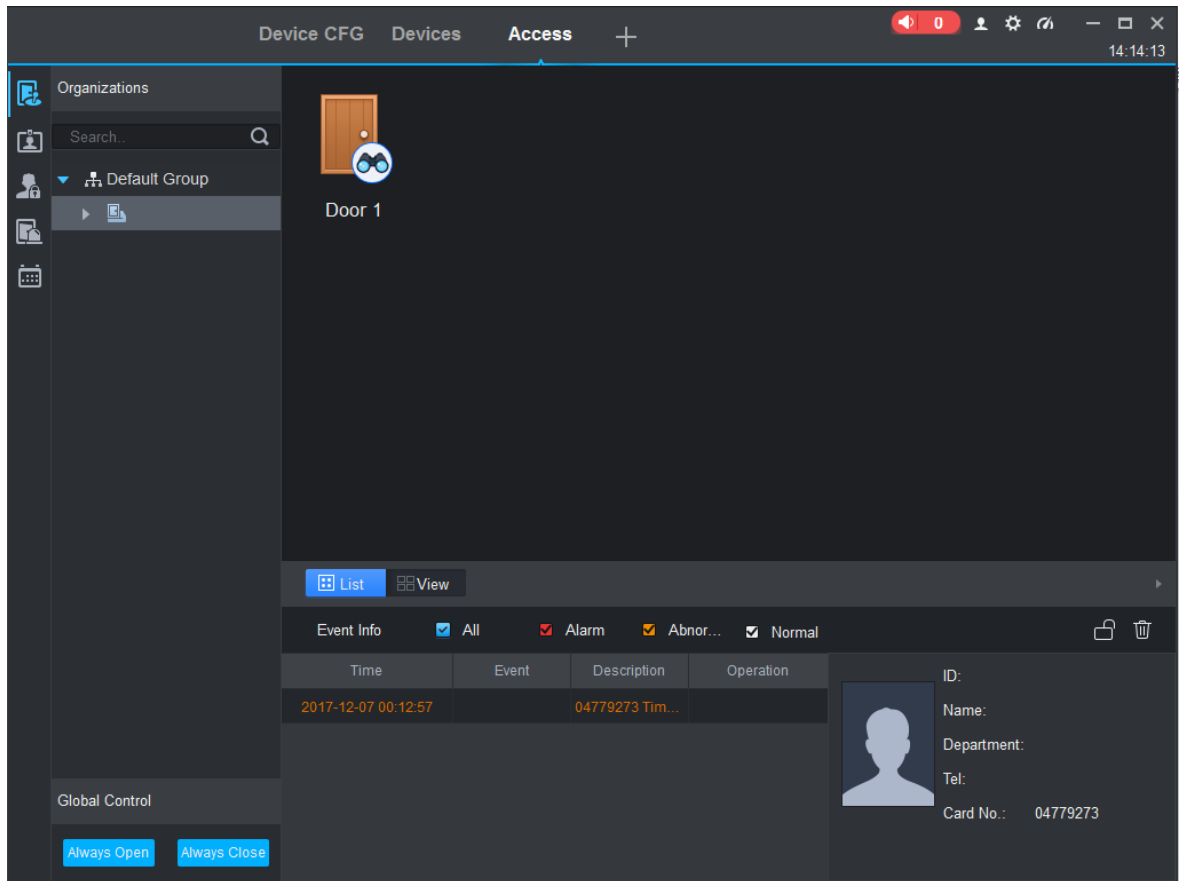

Figure 5-7

6

Technical Parameters

Classification	Name	Parameter Value
System parameter	Main processor	32-bit processor
Door control parameter	Lock control	1-channel
	Door sensor	1-channel
	Exit button	1-channel
	External reader	1-channel (RS485, Wiegand)
Function	Door overtime alarm	Give an overtime alarm when door opening time exceeds "door overtime". This function shall be set.
	Intrusion alarm	Give an intrusion alarm if someone intrudes without swiping card or inputting password.
	Duress alarm	Give a duress alarm if you enter with duress card.
	Tamper alarm	Tamper alarm button will give a tamper alarm if the access control device is tampered.
	Unlocking mode	Support card, card + password, user ID+ password.
	Remote verification	Support bonding with period.
	Schedule	128 groups
	Period	128 groups
	Holiday	128 groups
	Network upgrade	Upgrade the device through network.
	Patrol card	Patrol card can be swiped and records at patrol points. Patrol card cannot unlock the door.
Guest card	Set the use times of the card. The card will lose effect in case of exceeding the use times.	
Interface parameter	Network interface	1
	RS485 interface	1
General parameter	Power supply	DC 12V
	Power consumption	≤2W (excluding reader)
	Working temperature	-30℃~+60℃
	Working humidity	5%~95%
	Atmospheric pressure	86kPa~106kPa
	Dimension	142mm×62mm×23mm
	Weight	1.0kg
	Installation mode	Surface mounting